

KX-H 系列

脉冲光纤激光打标机

平均输出功率

20W / 30W / 40W / 50W / 100W



金属产品打图案



不锈钢打字符



机型介绍

PRODUCT DESCRIPTION

码清激光的KX-H系列光纤激光打标机采用的是**海富激光**光源，是一款全能型的打标设备，由于其在打标过程中 适应性强、维护量少、且无耗材，因此常被用于金属和塑料加工行业 进行精确、高效的直接产品标识打标。

光纤系列产品采用1064nm波长激光器，适用于**铁、铜、铝、金、银**等各类金属材质，及PC、ABS、PVC、PC+ABS等部分非金属材料。广泛应用于3C、汽车零配件、电子元器件、集成电路（PC）、电工电器、精密器械、五金制品、建材、钟表、首饰饰品、工艺礼品等行业。

机型尺寸

PRODUCT SIZE

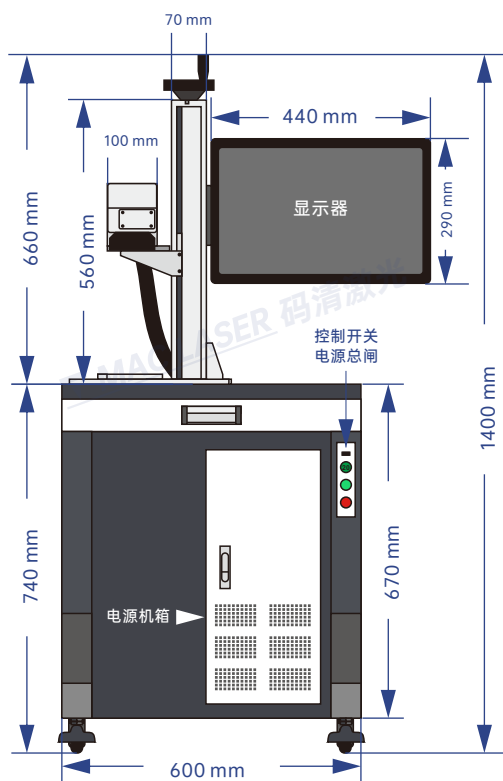

设备正面

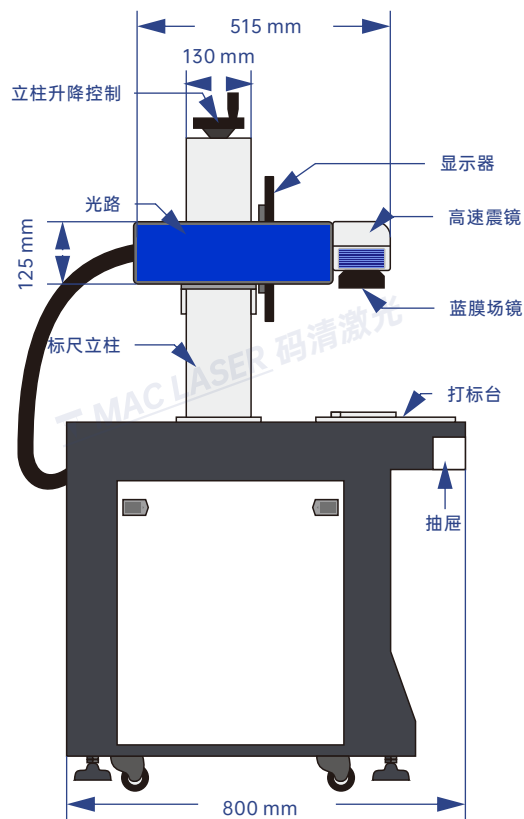

设备侧面

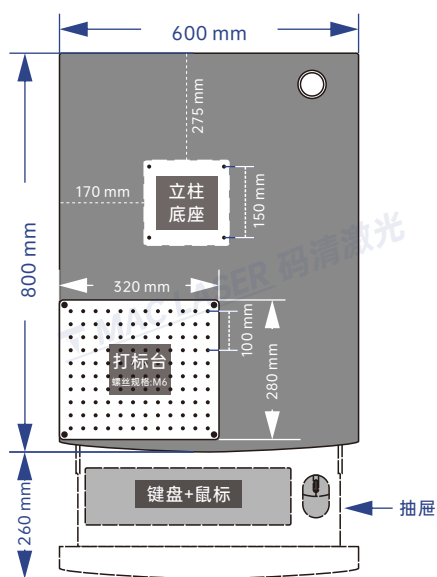

设备桌面 (俯视)



机型参数

MODEL
PARAMETERS

KX-H

脉冲光纤激光打标机系列

KX-H 系列采用的是 海富激光 的调Q脉冲光纤激光器，该激光器具有高稳定性、高脉冲能量、高峰值功率、高打标效率、高防反能力、低功耗、免维护的特点，应有范围广泛。

型号		KX-200H	KX-201H	KX-300H	KX-301H	KX-400H	KX-500H	KX-1000H
激光参数	激光器型号	HPFL-20L	HPFL-20	HPFL-30L	HPFL-30	HPFL-40	HPFL-50	HPFL-100
	输出功率	20W	20W	30W	30W	40W	50W	100W
	光束质量M ²	≤1.3	≤1.3	≤1.3	≤1.5	≤1.5	≤1.5	≤1.8
	脉冲重复频率	30-60 kHz	30-60 kHz	30-60 kHz	30-60 kHz	50-80 kHz	50-80 kHz	50-200 kHz
	激光波长	1064±5						
	输出功率稳定性	< 3%						
	设计寿命	约100000工作小时（非使用寿命）						
光学特性	打标范围	100~300mm（范围可选）						
	雕刻深度	≤1mm（视功率和时间而定）						
	雕刻速度	≤10000mm/s						
	重复精度	±0.002						
	最小标记线宽	0.1mm						
	最小字符高度	0.15mm						
使用环境	冷却方式	内置风冷						
	系统供电	500W / 220V / 50Hz（可接110V）						
	温度、湿度	0~40°，30%≤RH≤85%，超出范围使用时需安装空调						
	油雾、凝露	不允许						
其他参数	操作系统	Windows操作系统						
	文件格式	WINDOWS操作系统字库的所有字体/字型（标准USB输入）						
	外型尺寸	800X600X1400 mm						
	打包尺寸	860X730X1050 mm						
	整机重量	约75kg						

注：不同功率（W）的激光打标机在打标精度、深度、速度、色深以及使用寿命等方面均有差异，选购时请根据打标产品和需求，与码清的业务人员沟通后再选择方案。



性能出色的硬件配置

设备主要配置：高品质的光纤激光器 + 双红光金属振镜 + 工控电脑主机 + 工业显示屏



海富光纤激光器

采用海富激光高品质光源，光斑质量好，光功率密度均匀，输出光功率稳定，具有无漏光、抗高反等特点



双红光金属振镜

金属机身结构，内置双红光打标指示，具有免调节、免维护、高稳定性的优点，可升级高速数字扫描振镜



工控电脑主机

内置Windows系统，兼容丰富，支持多种软件，可接各种扩展外设，坚固耐用，散热性卓越



工业显示屏

1440*900全高新分辨率，低能耗设计
工业显示屏



标记持久，耐腐蚀

借助强脉冲激光束将标记直接打在表面上，使表面上产生颜色极深、高对比度的标记，实现视角均匀的持久性标记，具备耐腐蚀性。

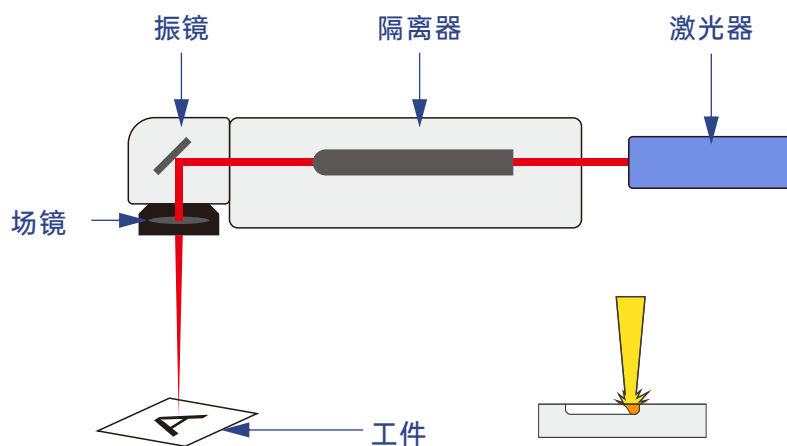

激光器产生高能量的激光光束，经场景聚焦，聚焦后的极小光斑作用在待加工材料表面，使材料表面氧化、熔融，甚至气化，从而产生颜色或深度等变化，达到激光标记的目的。



应用简便、安全、精准易上手

采用台式电脑配键盘、鼠标以及液晶显示器，Windows操作方式。

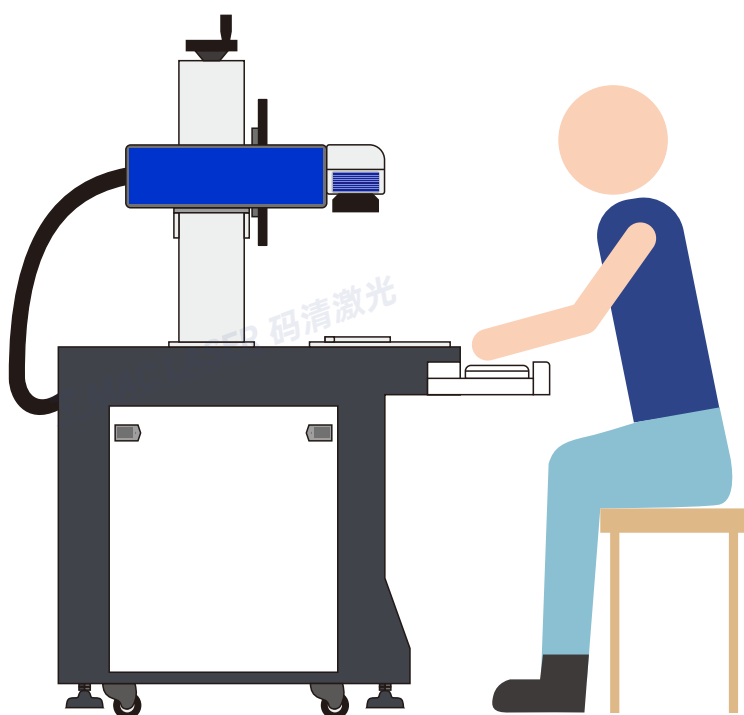

4

正版打标软件

基于Windows系统的全中文界面，方便于日常应用，内容直观。

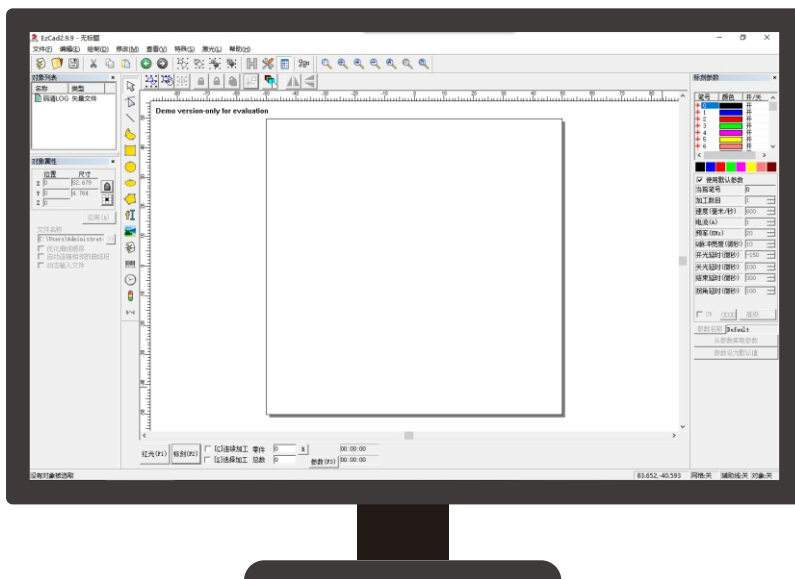

5

免费画图设计

提供免费的画图设计，矢量图格式转换，专职设计师对接，终身有效。

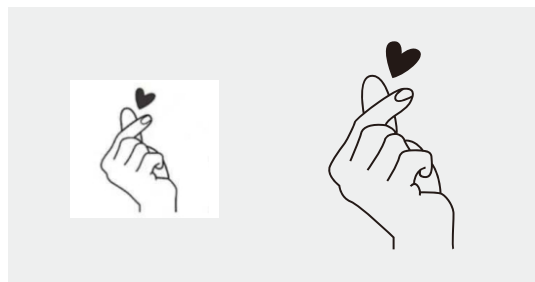
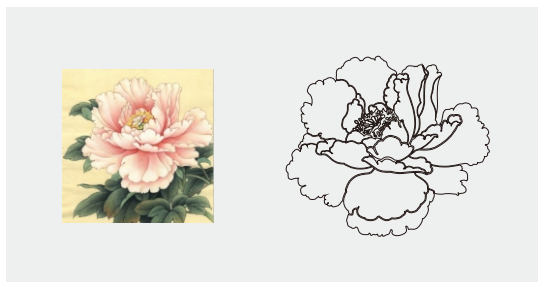



一年保修，终生维护

设备实行三包：免费托运、一年保修、终生维护服务，可上门安装调试。



免费托运
Free shipping



一年保修
One year free warranty



终生维护
Life-long repair



上门服务
Door-to-door service



用途灵活，应用广泛

该系列打标机用途灵活，应用广泛，满足您使用需求。



3C数码
3C Digital



汽车零配件
Automobile parts

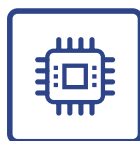

电子元器件
Electronic Component



电工电器
Electrical appliances



精密器械
Precision equipment



五金制品
Hardware products



钟表饰品
Watch accessories



医疗器械
Medical instruments

3C数码

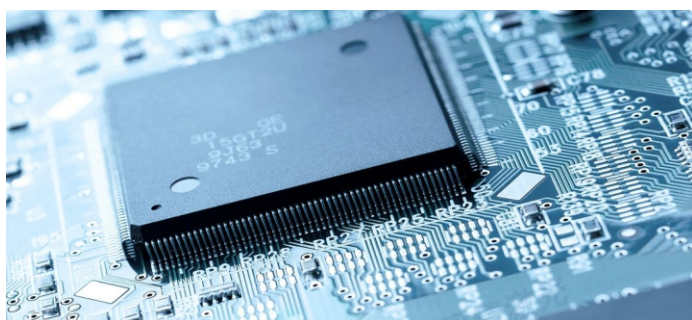

● 电脑CPU标记

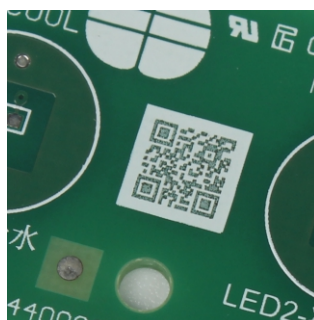

● 电路板二维码标记



● 笔记本键盘标记



● 摄影灯LOGO标记



● 移动电源LOGO标记



● 手机元器件标记

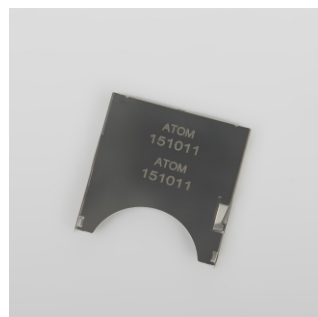

● 内存卡盖标记

汽车配件/五金制品



● 汽车零铸件标记



● 五金工具标记



● 汽车配件标记



● 设备部件标记



● 轴承圆环标记



● 精雕钻头标记

医疗器械/精密器械



● 手术刀标记



● 手术镊夹标记



● 医疗器具阀门标记

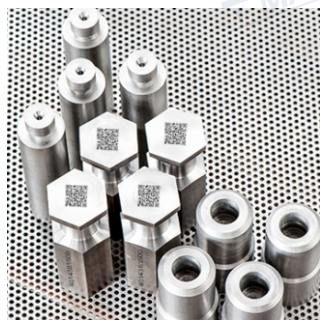

● 砵码标记



● 设备导管标记



● 精密器械标记



● 器械工件标记

首饰饰品/工艺礼品/其他



● 手饰标记



● 戒指标记



● 白金戒指标记



● 便携钢制酒壶标记



● 手表标记



● 高端钢笔标记



● 保温杯标记

配件选购

OPTIONAL ACCESSORIES

金属振镜头



● 不带双红光振镜MACF1003



● 带双红光振镜MACF1006



● 高速数字扫描振镜MACF1016

旋转夹具



● 标准旋转夹具 S3



● 戒指旋转夹具 S4

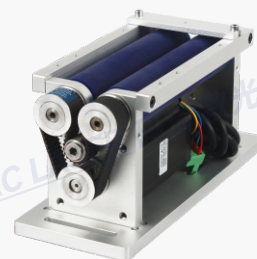

● 滚轴旋转台 S5

电动升降立柱

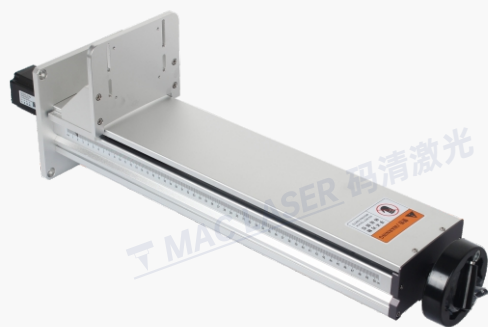

● 电动升降立柱（底部电机）

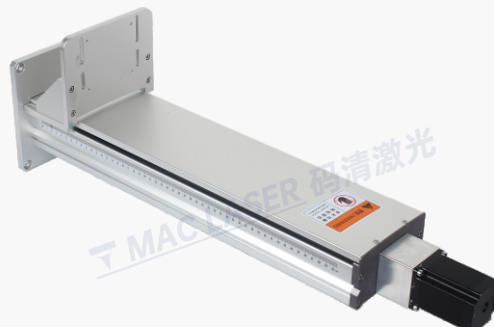

● 电动升降立柱（顶部电机）